

A = 203 mm

B = 660 mm

C = 762 mm

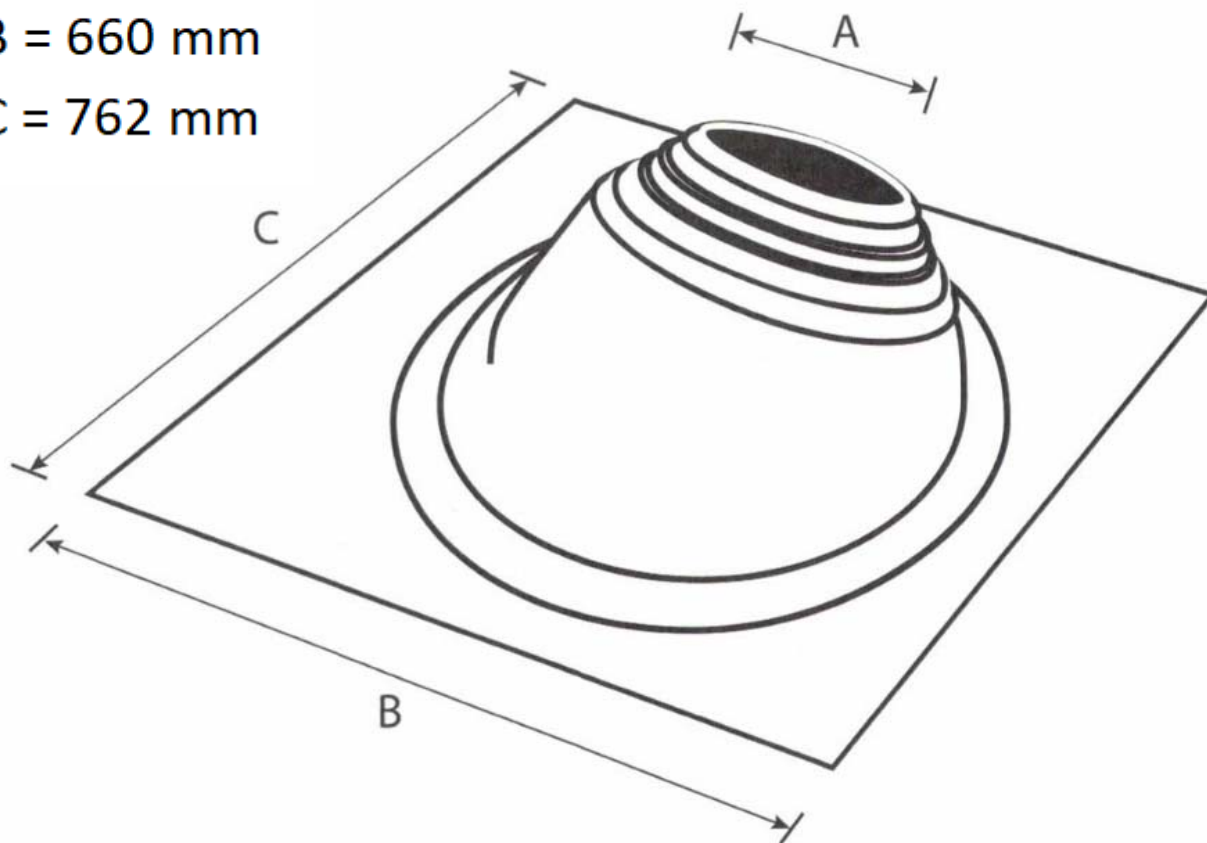

	A-Top opening	5-5/8" (142mm)
	B-Pull to suit pipe size	8" - 11" (203 - 279mm)
	C-Base	26" X 30" (660 X 762mm)

Unit of measure: mm

Hekon art. : SQ201RESBL