



(5)

Schachtafdekking  
Finition pour gaine



(4)

Huls voor flexibel  
Moule pour flexible

(3)

Spanring  
Bride de sécurité



(2)

Condensaflaat - Inspectieluik - Basissteun  
Purge pour condensats – Trappe visite – Support de base



(1)

Sifon met 1,5 m condensaatlang  
Siphon avec 1,5 m flexible pour condensats

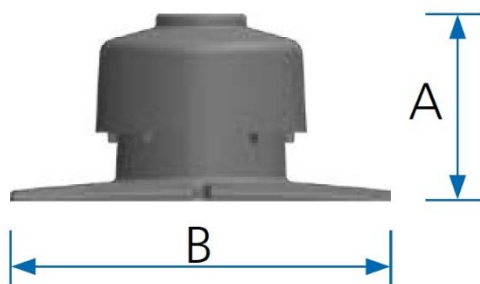

A

A = 193 mm

B = 400 mm

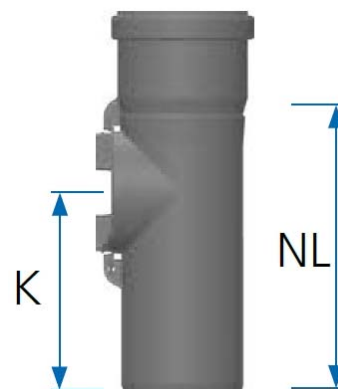

K

NL

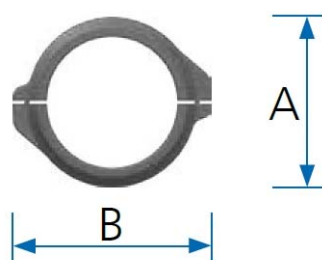

A

A = 188 mm

B = 207 mm

K = 190 mm

NL = 261 mm

Unit of measure: mm

Hekon art. : ATPPS160-BSET