

SECTION A-A

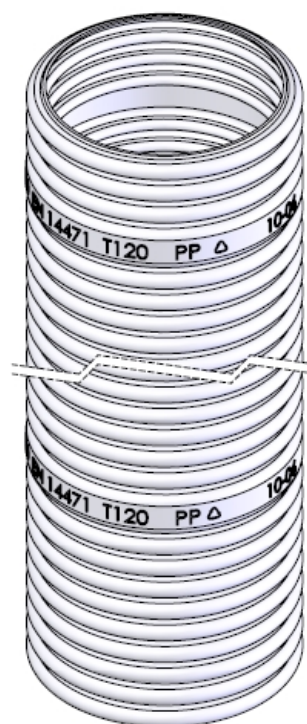
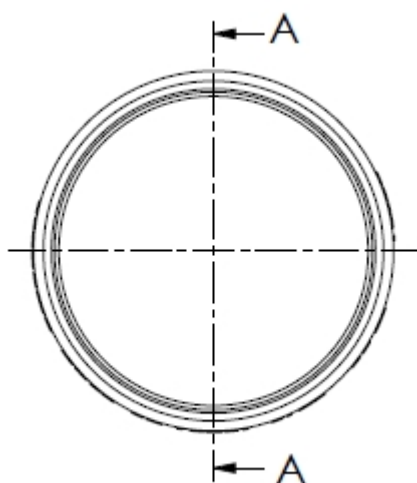

L (m)	Tolerance (m)
8	+0.5 / -0.0
12.5	+0.5 / -0.0
25	+0.5 / -0.0
50	+0.5 / -0.0
80	+0.5 / -0.0

Hekon art. : CD060-FL25