

SECTION A-A

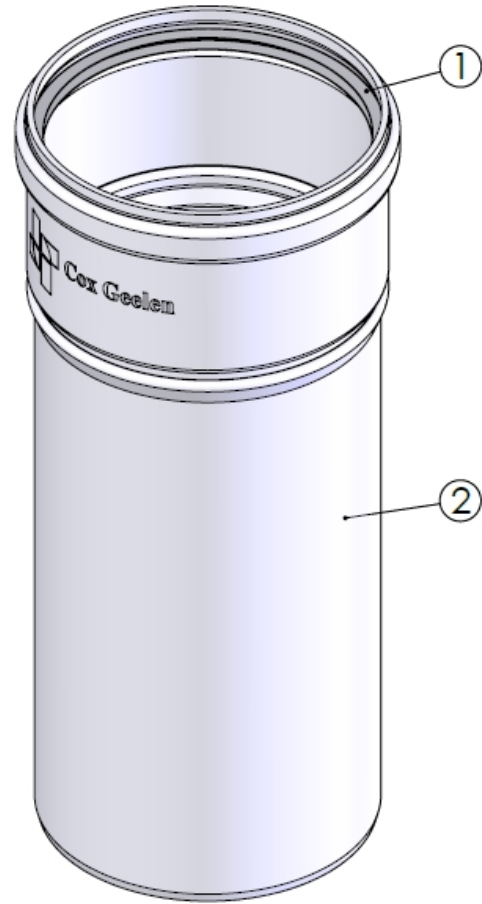

Lnom.	L1	L2
220*	220	165
250	245	190
500	495	440
1000	995	940
1950	1945	1890

*: Lnom = L1

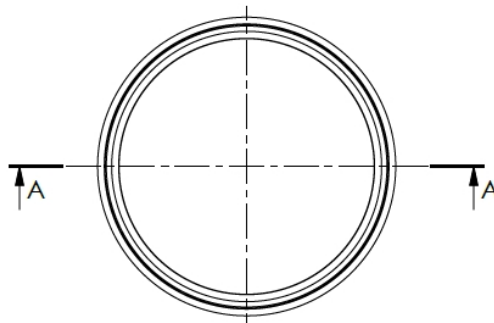

Unit of measure: mm

2	1	Flue pipe $\varnothing 100$	CoxPP
1	1	Seal EPDM Flue gas $\varnothing 100$ S	EPDM Flue gas
Pos.	QTY.	Description	Material

Hekon art. : CD100-2000