

SECTION A-A

Type	D1	D2
70	69.8	71
80	79.8	81
90	89.8	91
100	99.8	101

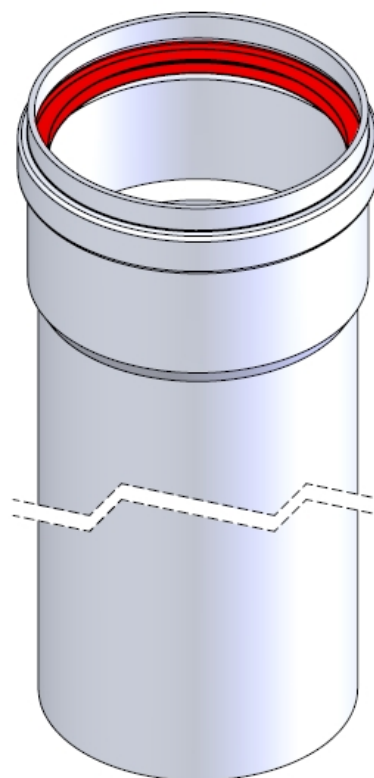

L
250 ± 2
500 ± 3
1000 ± 5
1500 ± 5
2000 ± 7
2500 ± 7
2750 ± 7
3000 ± 10

2	1	Seal VMQ Flue gas	VMQ Flue gas
1	1	CoxFix Pipe	EN-AW-6060
Pos.	QTY.	Description	Material

Hekon art. : DWA080-0250