

Ø dbu	83	92	100	105	111	121	125	131	139	150	160	170	180	200
B	218	218	218	218	218	218	218	218	218	218	218	218	218	270
H	52	52	52	52	52	52	52	52	52	52	52	52	52	42

Type 083 t.e.m. 180

Type 200

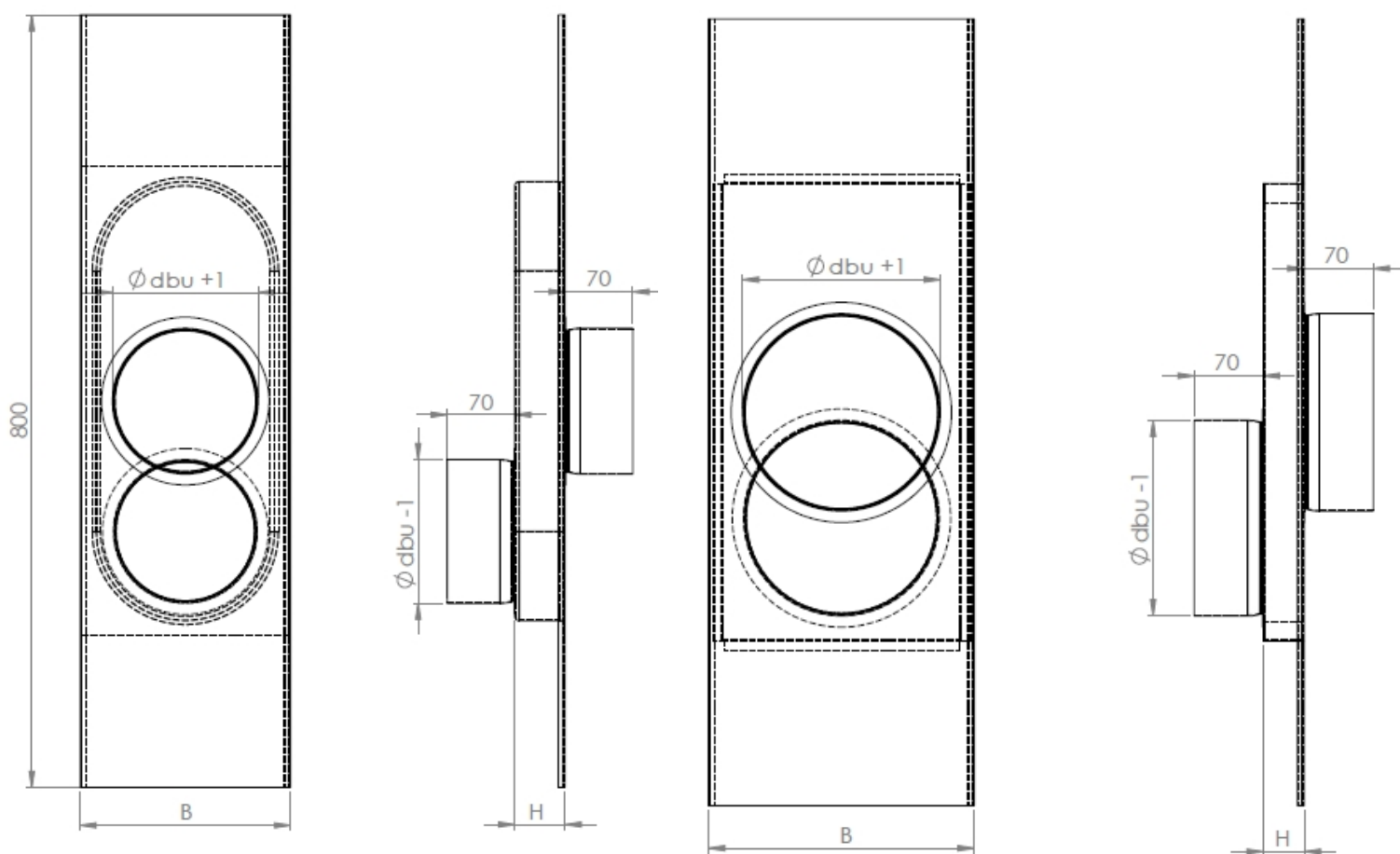

Unit of measure: mm

ITEM.	QTY.	DESCRIPTION	PART Nr.	Material
1	1	Schuifplaat	--	EN 10142 DX51D Z275 (Galva)
2	1	Schuifelement kanaal	--	EN 10142 DX51D Z275 (Galva)
3	1	Aansluiting M	--	EN 10142 DX51D Z275 (Galva)
4	1	Aansluiting V	--	EN 10142 DX51D Z275 (Galva)

Hekon art. : GE180-OREG

Ødbu	83	92	100	105	111	121	125	131	139	150	160	170	180	200
B	218	218	218	218	218	218	218	218	218	218	218	218	218	270

Unit of measure: mm

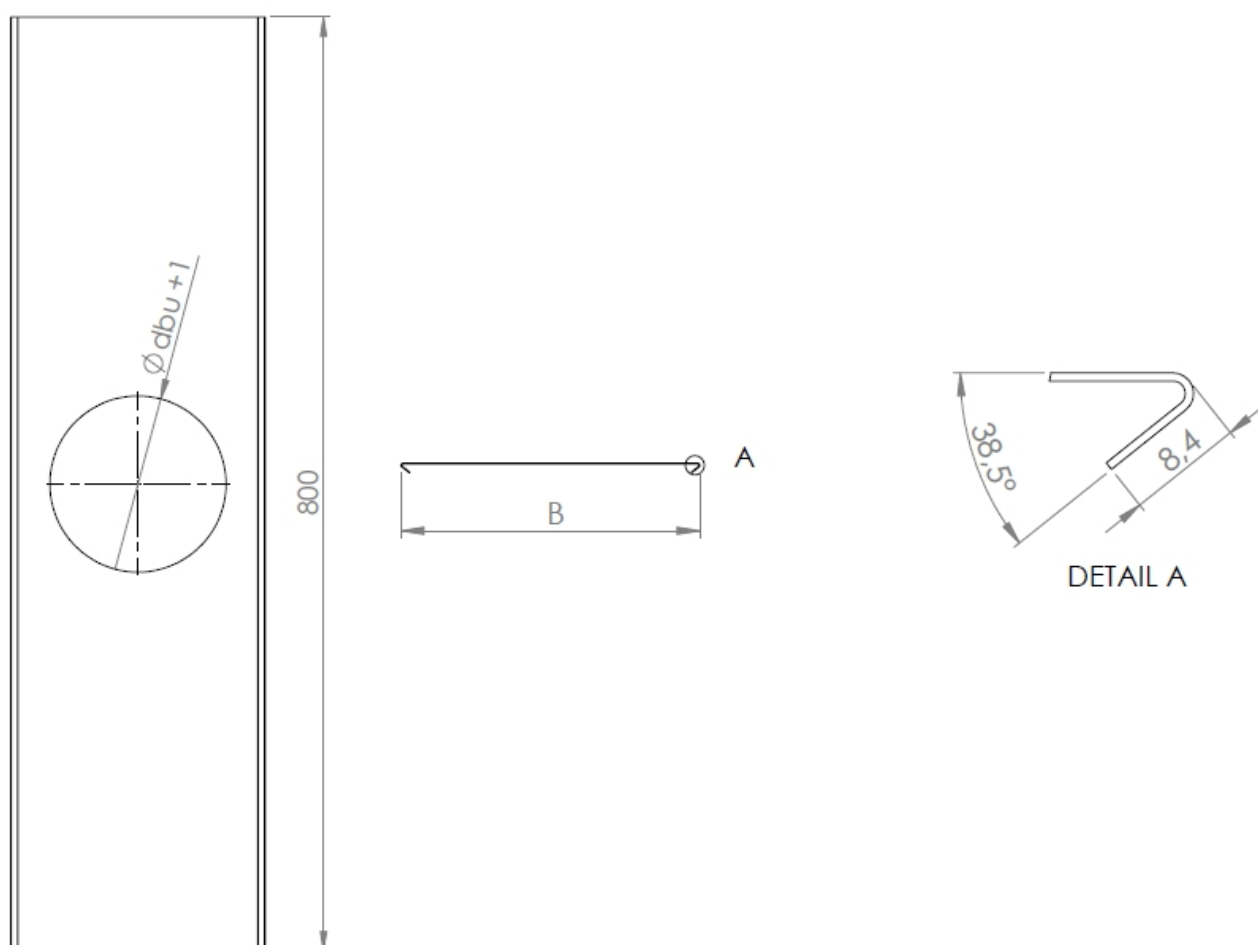

Hekon art. : GE180-OREG

Ødbu	83	92	100	105	111	121	125	131	139	150	160	170	180	200
------	----	----	-----	-----	-----	-----	-----	-----	-----	-----	-----	-----	-----	-----

Unit of measure: mm

Type 083 t.e.m. 180

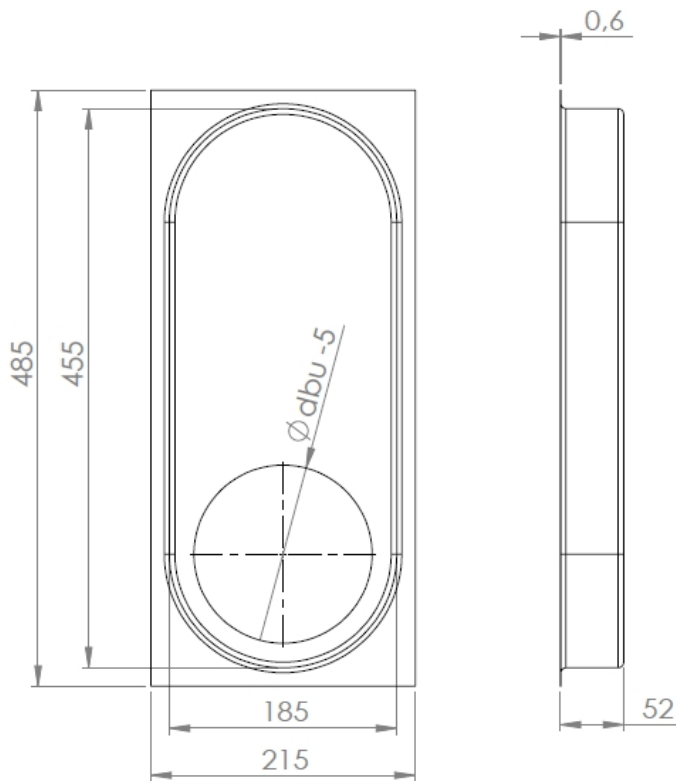

Type 200

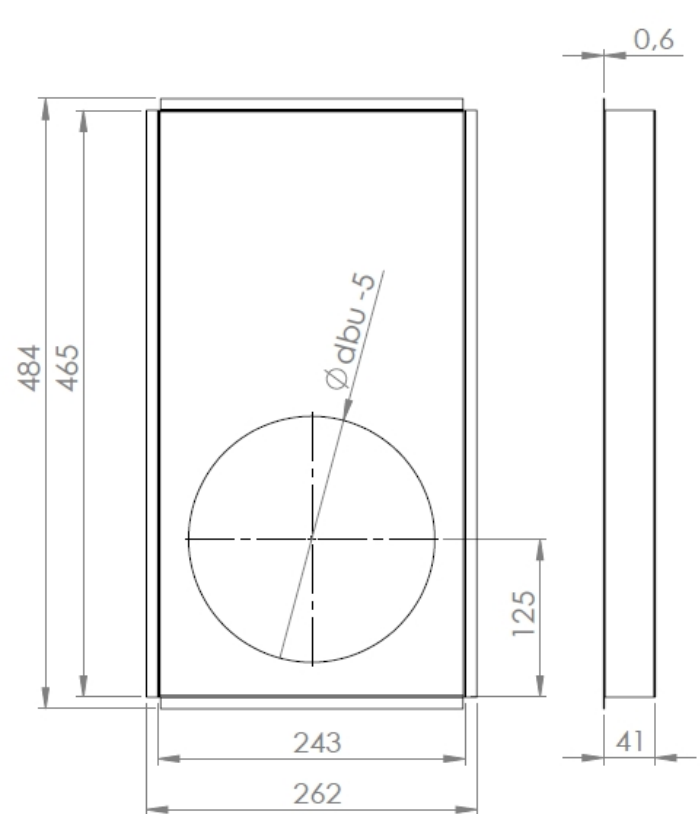

Hekon art. : GE180-OREG

Ødbu	83	92	100	105	111	121	125	131	139	150	160	170	180	200
------	----	----	-----	-----	-----	-----	-----	-----	-----	-----	-----	-----	-----	-----

Unit of measure: mm

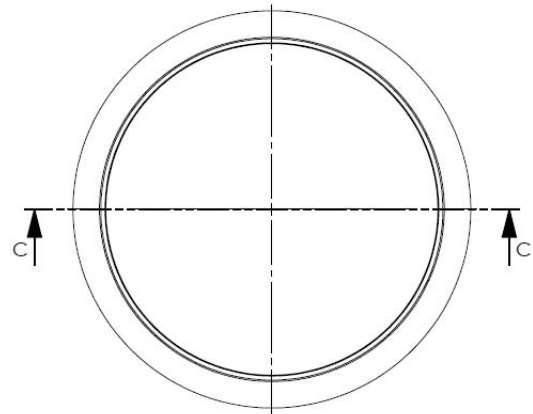
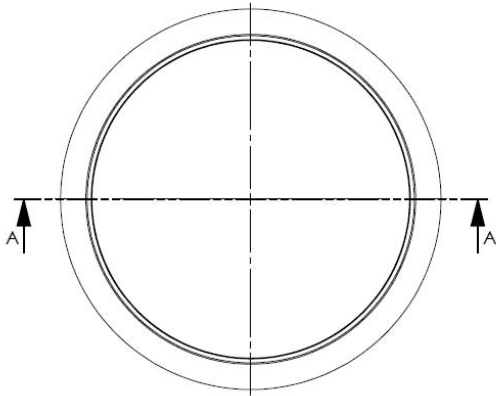
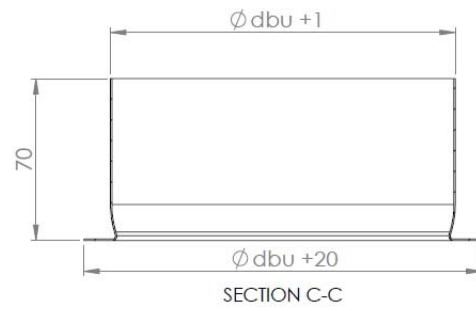
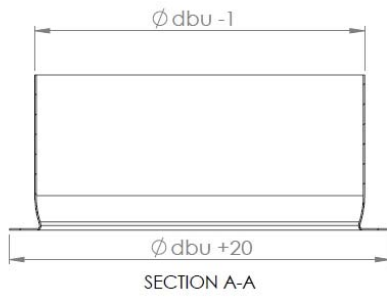

Hekon art. : GE180-OREG