

SECTION A-A

øD1	øD2	L
60	100	150
70	110	150
80	125	150
90		
100	150	150/250
110		
130		
150		

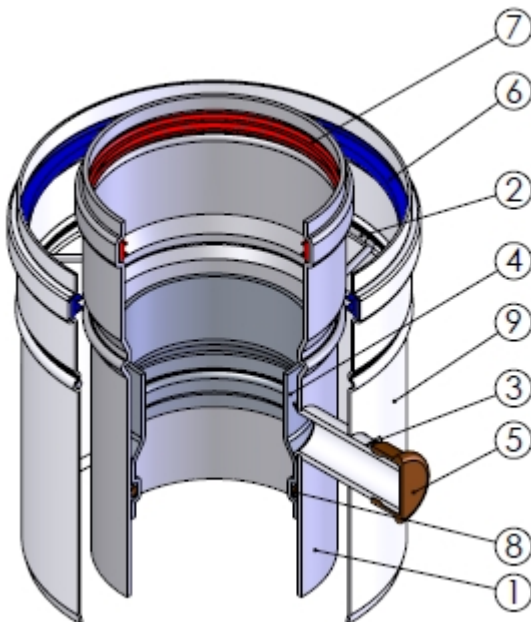

Pos.	QTY.	Description	Material
9	1	Air pipe ø125 L140	EN-AW-1050A
8	1	O-Ring	FKM
7	1	Seal ø80	VMQ Flue gas
6	1	Seal ø125	VMQ Air
5	1	Cap, Flue gas, Brown	Viton
4	1	Condensation drain	EN-AW-1050A
3	1	Testpoint	EN-AW-6060
2	1	Spring	AISI 301
1	1	Flue pipe ø80	EN-AW-6060
Pos.	QTY.	Description	Material

Hekon art. : GR80/125COND