

Emboîtement 60 mm
Mof – spie verbinding 60 mm

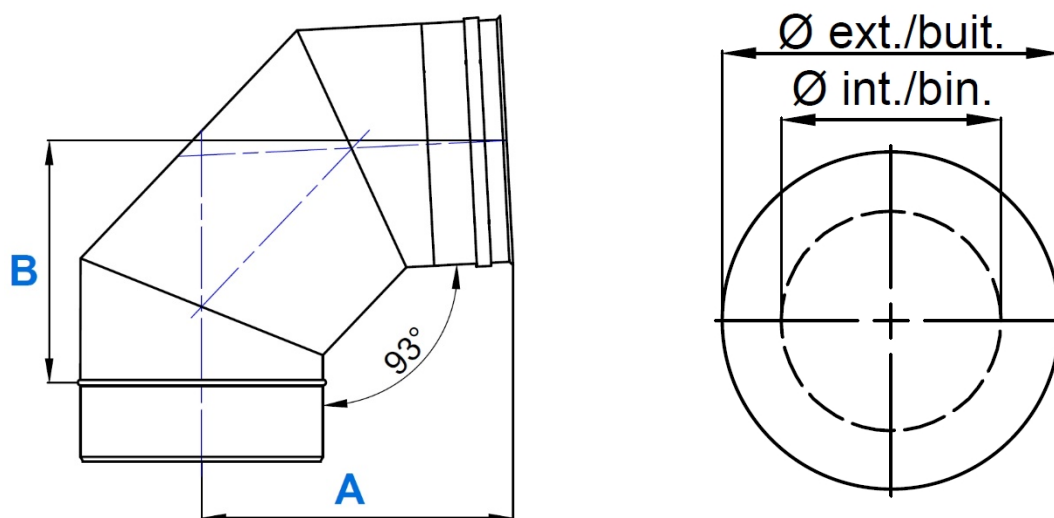

Ø int. / bin.	110	130	180	200
Ø ext. / buit.	180	200	250	300
A	249	259	284	309
B	186	196	221	246

Unit of measure: mm

Hekon art. : GTCLV130-0087