

Unit of measure: mm

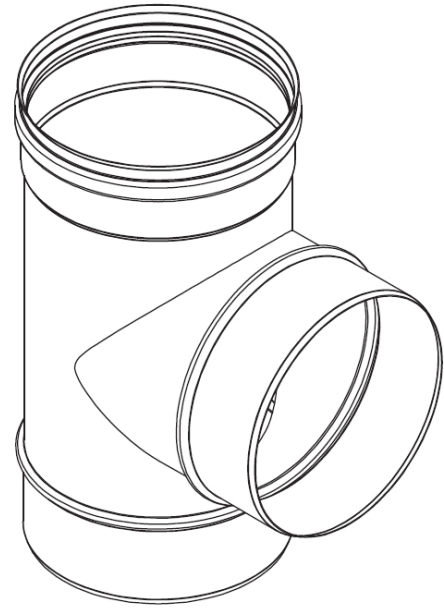
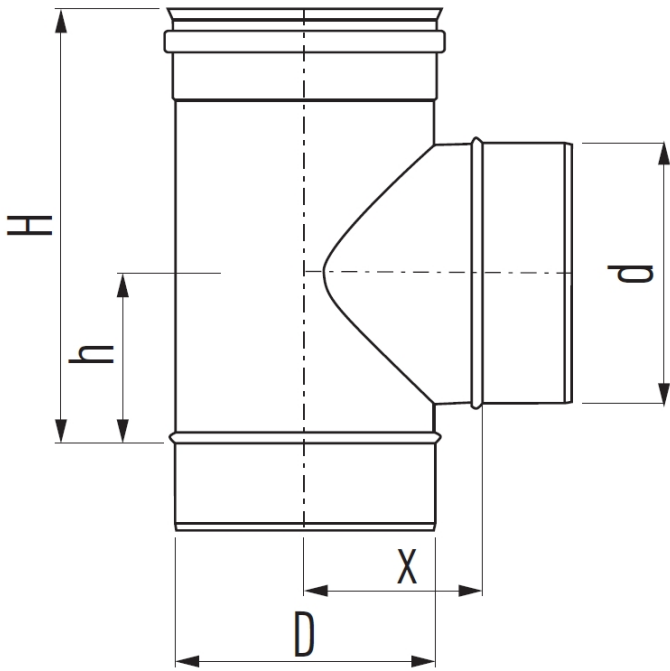

Table for H D = Body												Table for x D = Body														
d = branch	100	130	150	180	200	250	300	350	400	450	500	600	d = branch	100	130	150	180	200	250	300	350	400	450	500	600	
80	200	200	200	200	200	200	200	200	200	200	200	200	80	80	95	105	120	130	155	180	205	230	255	280	330	
100		200	200	200	200	200	200	200	200	200	200	200	100		95	105	120	130	155	180	205	230	255	280	330	
130			250	250	250	250	250	250	250	250	250	250	130			105	120	130	155	180	205	230	255	280	330	
150				250	250	250	250	250	250	250	250	250	150				120	130	155	180	205	230	255	280	330	
180					300	300	300	300	300	300	300	300	180					130	155	180	205	230	255	280	330	
200						300	300	300	300	300	300	300	200						155	180	205	230	255	280	330	
250							350	350	350	350	350	350	250							180	205	230	255	280	330	
300								450	450	450	450	450	300								205	230	255	280	330	
350									500	500	500	500	350									230	255	280	330	
400										550	550	550	400										230	255	280	330
450											630	630	450											255	280	330
500												680	500												280	330

Table for h D = Body												
d = branch	100	130	150	180	200	250	300	350	400	450	500	600
80	75	75	75	75	75	75	75	75	75	75	75	75
100		75	75	75	75	75	75	75	75	75	75	75
130			100	100	100	100	100	100	100	100	100	100
150				100	100	100	100	100	100	100	100	100
180					125	125	125	125	125	125	125	125
200						125	125	125	125	125	125	125
250							150	150	150	150	150	150
300								200	200	200	200	200
350									225	225	225	225
400										250	250	250
450											290	290
500												315

Hekon art. : ISR16250T9113