

Unit of measure: mm

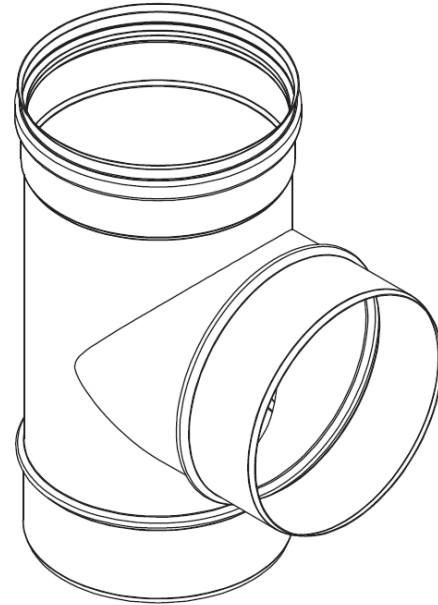
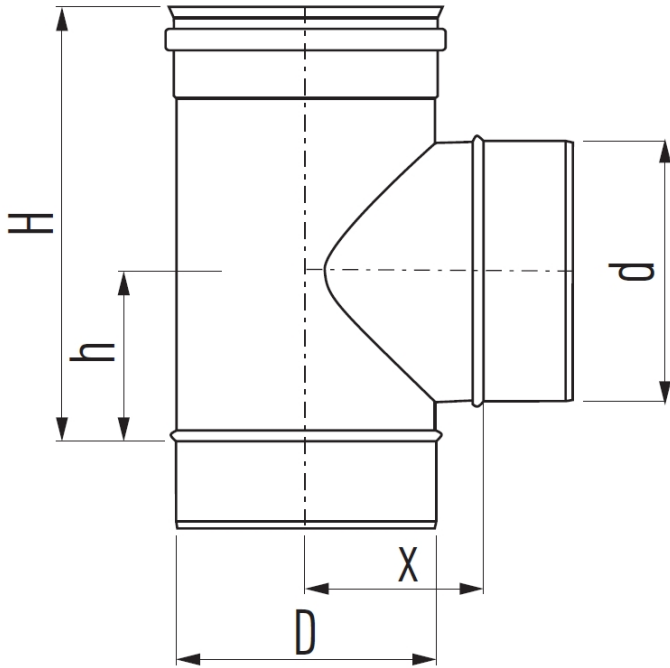

d = branch	100	130	150	180	200	250	300	350	400	450	500	600
80	200	200	200	200	200	200	200	200	200	200	200	200
100		200	200	200	200	200	200	200	200	200	200	200
130			250	250	250	250	250	250	250	250	250	250
150				250	250	250	250	250	250	250	250	250
180					300	300	300	300	300	300	300	300
200						300	300	300	300	300	300	300
250							350	350	350	350	350	350
300								450	450	450	450	450
350									500	500	500	500
400										550	550	550
450											630	630
500												680

d = branch	100	130	150	180	200	250	300	350	400	450	500	600	
80	80	95	105	120	130	155	180	205	230	255	280	330	
100		95	105	120	130	155	180	205	230	255	280	330	
130			105	120	130	155	180	205	230	255	280	330	
150				120	130	155	180	205	230	255	280	330	
180					130	155	180	205	230	255	280	330	
200						155	180	205	230	255	280	330	
250							180	205	230	255	280	330	
300								205	230	255	280	330	
350									230	255	280	330	
400										230	255	280	330
450											255	280	330
500												280	330
													330

d = branch	100	130	150	180	200	250	300	350	400	450	500	600
80	75	75	75	75	75	75	75	75	75	75	75	75
100		75	75	75	75	75	75	75	75	75	75	75
130			100	100	100	100	100	100	100	100	100	100
150				100	100	100	100	100	100	100	100	100
180					125	125	125	125	125	125	125	125
200						125	125	125	125	125	125	125
250							150	150	150	150	150	150
300								200	200	200	200	200
350									225	225	225	225
400										250	250	250
450											290	290
500												315

Hekon art. : ISR16300T9200