

Longueur utile = LU
Emboîtement = E

Nuttige lengte = NL
Ineenvoeging = I

Ø int. / bin.	100	110	130	180	200	230
Ø ext. / buit.	150	180	200	250	300	350
A	105	110	110	120	125	130

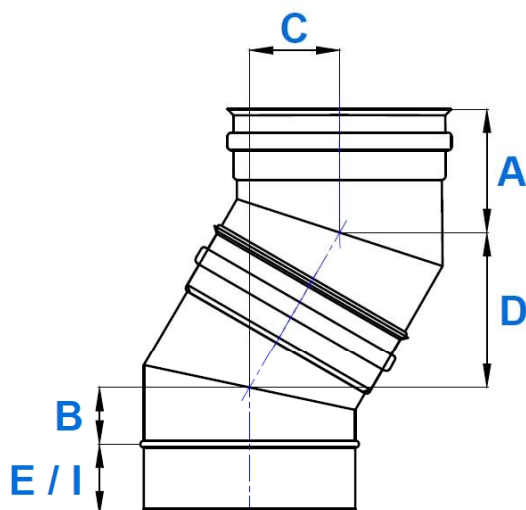
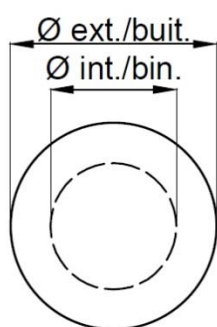

Ø int. / bin.	100	110	130	180	200	230
Ø ext. / buit.	150	180	200	250	300	350
A	105	110	110	120	125	130
B	45	50	50	60	65	70
C	75	80	80	90	95	100
D	130	139	139	156	165	173
E	60	60	60	60	60	60

Unit of measure: mm

Hekon art. : ITCLV230-0030