

A = 69 mm

B = 508 mm

C = 609 mm

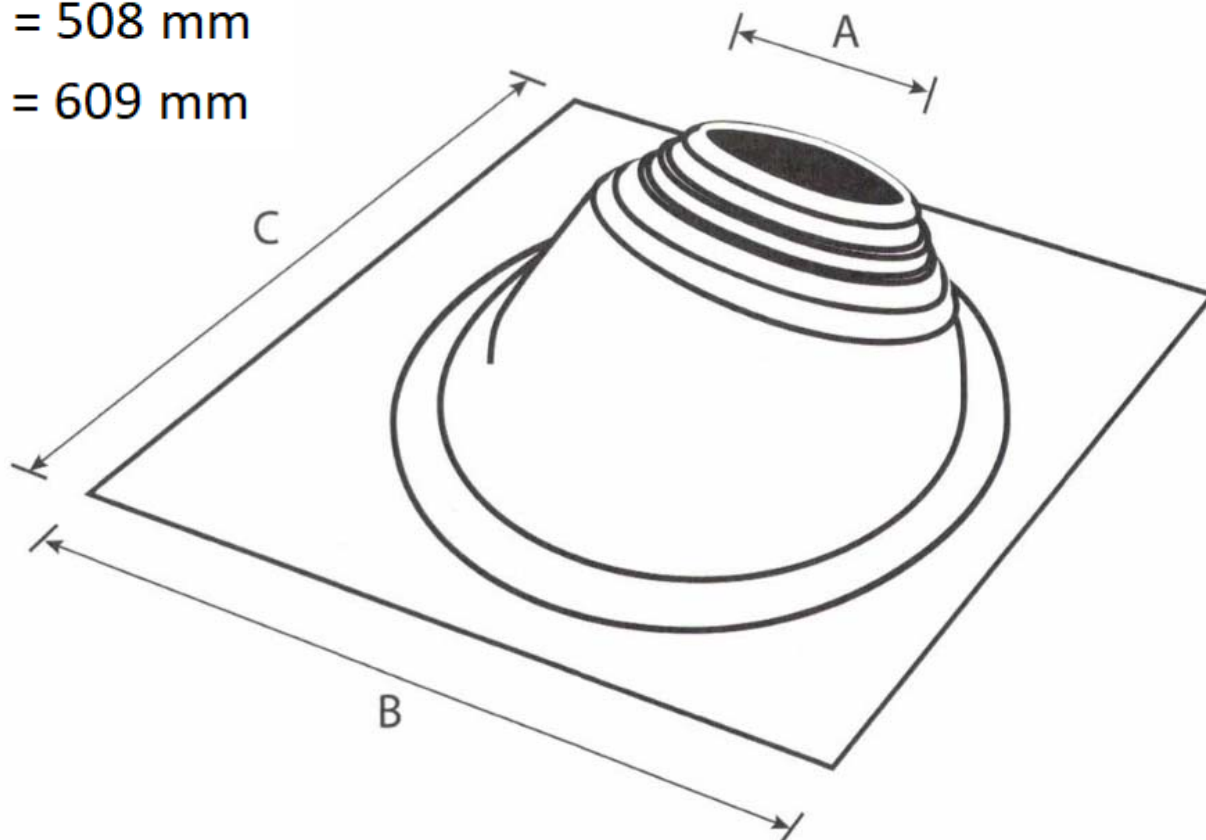

	A-Top opening	2-1/2" (63mm)
	B-Pull to suit pipe size	3" - 8" (76 - 203mm)
	C-Base	20" X 24" (508 X 609mm)

Unit of measure: mm

Hekon art. : SQ102RESTE